

This document is exclusive MARECO LUCE s.r.l., is strictly prohibited disclosure or reproduction, even partial, as well the use of without written consent of MARECO LUCE s.r.l. The company reserves the right to change models, dimensions and materials at any time without notice.

PRODUCT DATA SHEET

Sfera Ø250 Led IP44

Code : 1080282F

PRODUCT FAMILY

- Globe-shaped LED luminaire complete with base (IP44) for use with poles or brackets Ø60mm on top, for uplight installation

MATERIAL CHARACTERISTICS

- Spherical diffuser Ø250mm in PMMA (acrylic), with bayonet neck
 - Base made of self extinguishing V2 PC (polycarbonate)
 - Wiring includes a round covering cone for driver recovery made of highly resistant PC (polycarbonate)
 - A top cover and an antiglare louver made in NY-FV30% supports the LED's circuit
 - A2 stainless steel screws

COLOUR

- White
 - Transparent
 - Smoked

LIGHTING CHARACTERISTICS

- LED's lighting source in fixed position
 - Immediately ON at 100% of light flux
 - Monochromatic LED module (18 Led's)
 - Led's Osram Duris S2
 - Round symmetrical light throw

WIRING CHARACTERISTICS

- LED's module 6,8W
 - Built-in driver (350mA driver output)
 - Use only a flexible double insulation sheath (type HAR). The outer cable diameter must be less than Ø11mm and the thickness of the inner electrical wires must range between 1 and 2.5mmq

INSTALLATION AND ORDINARY MAINTENANCE CHARACTERISTICS

- Luminaire for use with poles or brackets Ø60mm on top, to be mounted through a screw (included)
 - Self-adjusting cord block for cable max Ø10mm
 - Ordinary maintenance not necessary
 - Extraordinary maintenance can be conducted by removing the diffuser
 - The "T"-3 ways IP68 connector cannot be placed inside the pole Ø60mm

DIMENSIONS

- Ø250x257mm

OPTIONAL ACCESSORIES TO BE ORDERED SEPARATELY:

- IP68 connector - COD.CS093000
 - Mistral - COD.1480000N
 - Palù - COD.1000500N
 - Vico - COD.1000150N
 - Jolly - COD.1490000N
 - Spike - COD.1460000N
 - Comet - COD.1461000N

TECHNICAL SPECS

- Type of Led's: Osram Duris S2
- Step MacAdam: 3
- Lifetime Led's: L70/B50>32.5Kh - Tc 93°C
- Lifetime Led's: L80/B20>19Kh - Tc 93°C
- Lifetime driver: 50Kh
- Warranty: 2 years

TECHNICAL SPECS 3000K/4000K - Transparent diffuser

- Led's output: 980lm@tc25°C
- Luminaire output: 297lm@ta25°C
- LED's efficiency: 144lm/W
- Luminaire efficiency: 37lm/W
- Led's consumption: 6.8W
- Luminaire consumption: 8W

TECHNICAL SPECS 3000K/4000K - White diffuser

- Led's output: 980lm@tc25°C
- Luminaire output: 235lm@ta25°C
- LED's efficiency: 144lm/W
- Luminaire efficiency: 29lm/W
- Led's consumption: 6.8W
- Luminaire consumption: 8W

TECHNICAL SPECS 3000K/4000K - Smoked diffuser

- Led's output: 980lm@tc25°C
- Luminaire output: 265lm@ta25°C
- LED's efficiency: 144lm/W
- Luminaire efficiency: 33lm/W
- Led's consumption: 6.8W
- Luminaire consumption: 8W

Rev 03-05/11/2019

Details

- Conformity with CEE directives
- Double insulation/class II
- IK08
- RG0
- CRI>80
- CLASS A+
- IP 44

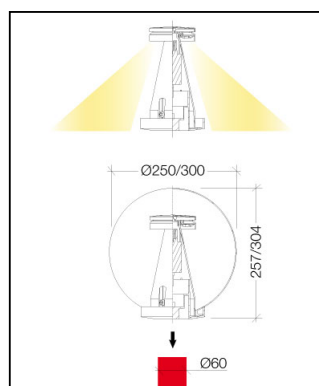

220-240V 50/60Hz 8W

