

This document is exclusive MARECO LUCE s.r.l., is strictly prohibited disclosure or reproduction, even partial, as well the use of without written consent of MARECO LUCE s.r.l..The company reserves the right to change models, dimensions and materials at any time without notice.

PRODUCT DATA SHEET

Bridge

Code : 1303001B

PRODUCT FAMILY

- Outdoor Residential for direct wall fixing, complete with spherical diffuser Ø150mm, Ø200mm, Ø250mm (IP44)

MATERIALS CHARACTERISTICS

- Bracket and wall fixing base in NY/FV30%, black colour
 - Spherical diffuser in white opal PMMA (acrylic) Ø150mm, Ø200mm or Ø250mm
 - A2 stainless steel screws

COLOR

- Black/white opal

LIGHTING CHARACTERISTICS

- Fluorescent light source, fixed position
 - Round symmetrical light throw

WIRING CHARACTERISTICS

- Luminaire designed for max 8W FBT lamp E27 lamp holder supply tension 220-240V 50-60Hz (diffuser Ø150mm)
 - Max lamp dimension allowed Ø70xL110mm (diffuser Ø150mm)
 - Luminaire designed for max 15W FBT lamp E27 lamp holder supply tension 220-240V 50-60Hz (diffuser Ø200mm)
 - Max lamp dimension allowed Ø70xL160mm (diffuser Ø200mm)
 - Luminaire designed for max 21W FBT lamp E27 lamp holder supply tension 220-240V 50-60Hz (diffuser Ø250mm)
 - Max lamp dimension allowed Ø85xL180mm (diffuser Ø250mm)
 - Terminal for power supply cables 2x2.5mmq

INSTALLATION AND MAINTENANCE CHARACTERISTICS

- Luminaire for installation on boundary walls, fixed with 2 screws (not supplied)
 - Ordinary maintenance by removing the bayonet-connection diffuser

DIMENSIONS

- Ø150x228x223mm
 - Ø200x253x273mm
 - Ø250x278x323mm

• Warranty: 2 years

Rev 02-28/10/2019

Details

- Conformity with CEE directives
- Double insulation/class II
- IK08
- CLASS A+
- CLASS A
- IP 44

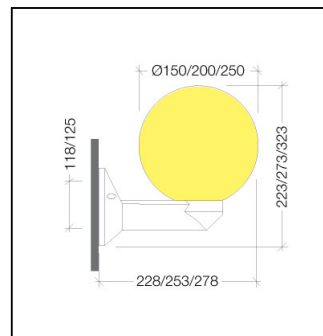

220-240V 50/60Hz 8W max E27

