

This document is exclusive MARECO LUCE s.r.l., is strictly prohibited disclosure or reproduction, even partial, as well the use of without written consent of MARECO LUCE s.r.l. The company reserves the right to change models, dimensions and materials at any time without notice.

PRODUCT DATA SHEET

Lira 40 Round

Code : 4040282W

PRODUCT FAMILY

- IP67 inground LED uplight Ø40mm, requiring recessed box for floor mounting, or retaining springs for false ceiling mounting

MATERIAL CHARACTERISTICS

- Housing in stainless steel AISI 316L
- AISI 316L stainless steel casting round ring Ø40mm and polished finish
- Flat, transparent, tempered glass diffuser, 6mm thick
- PMMA (acrylic) lens with high transmittance
- Max load 500Kg at 20Km/h
- Silicone gaskets
- A2 stainless steel screws

COLOUR

- Stainless steel

LIGHTING CHARACTERISTICS

- LED's lighting source in fixed position
- Immediately ON at 100% of light flux
- Monochromatic LED module (1 Led)
- Lenses in either: 7°, 22°, 33° and asymmetric elliptic 9°x20°

WIRING CHARACTERISTICS

- Metal PG9 cable gland
- Remote electronic driver compulsory
- Pre-wired with H05RN-F 2x0.5mmq cable (40cm) for the connection to the mains
- IPSC included: Protected against reversal of polarity, overvoltage and short circuit

INSTALLATION AND ORDINARY MAINTENANCE CHARACTERISTICS

- Inground uplight for use with recessed box accessory (to be ordered separately)
- Ceiling downlight for direct mounting, requiring Ø32mm hole with locking mechanism (supplied separately)
- Ordinary and extraordinary maintenance not necessary
- Drivers CS160017 or CS160024 cannot be placed inside the recessed box
- The "T"-3 ways and linear IP68 connector cannot be placed inside the recessed box

COMPULSORY ACCESSORY FOR PAVEMENT MOUNTING TO BE ORDERED SEPARATELY:

- Circular recessed box Ø100x80mm - COD.70000003
- Tubular recessed box Ø35x70mm - COD.70000007

COMPULSORY ACCESSORY FOR FALSE CEILING MOUNTING TO BE ORDERED SEPARATELY:

- False ceiling locking mechanism - COD.4000001W

OPTIONAL ACCESSORIES TO BE ORDERED SEPARATELY:

- Electronic driver 9W IP20 500mA - COD.CS160017 min 1 max 3 luminaires
- Multifunction electronic IP20 15W - COD.CS160024:
 - 350mA min 1 max 12 luminaires
 - 700mA min 1 max 6 luminaires
- IP68 connector - COD.CS093000
- "T"-3 ways IP68 connector - COD.CS093001

DIMENSIONS

- Ø40x56mm

TECHNICAL SPECS

- Step MacAdam: 4
- Lifetime Led's: L80/B50 - 40Kh Tc 70°C

- Warranty: 5 years

TECHNICAL SPECS 4000K - 350mA - 1W

- Led's output: 124lm@tc25°C
- Luminaire output 7°: 76lm@ta25°C
- Luminaire output 22°: 75lm@ta25°C
- Luminaire output 33°: 82lm@ta25°C
- Luminaire output 9°x20°: 82lm@ta25°C
- RG: 1

TECHNICAL SPECS 4000K - 500mA - 2W

- Led's output: 167lm@tc25°C
- Luminaire output 7°: 102lm@ta25°C
- Luminaire output 22°: 101lm@ta25°C
- Luminaire output 33°: 111lm@ta25°C
- Luminaire output 9°x20°: 111lm@ta25°C
- RG: 1

TECHNICAL SPECS 4000K - 700mA - 3W

- Led's output: 217lm@tc25°C
- Luminaire output 7°: 133lm@ta25°C
- Luminaire output 22°: 131lm@ta25°C
- Luminaire output 33°: 144lm@ta25°C
- Luminaire output 9°x20°: 144lm@ta25°C
- RG: 2<135cm

TECHNICAL SPECS 3000K - 350mA - 1W

- Led's output: 109lm@tc25°C
- Luminaire output 7°: 67lm@ta25°C
- Luminaire output 22°: 66lm@ta25°C
- Luminaire output 33°: 72lm@ta25°C
- Luminaire output 9°x20°: 72lm@ta25°C
- RG: 1

TECHNICAL SPECS 3000K - 500mA - 2W

- Led's output: 147lm@tc25°C
- Luminaire output 7°: 90lm@ta25°C
- Luminaire output 22°: 89lm@ta25°C
- Luminaire output 33°: 98lm@ta25°C
- Luminaire output 9°x20°: 98lm@ta25°C
- RG: 1

TECHNICAL SPECS 3000K - 700mA - 3W

- Led's output: 191lm@tc25°C
- Luminaire output 7°: 117lm@ta25°C
- Luminaire output 22°: 115lm@ta25°C
- Luminaire output 33°: 127lm@ta25°C
- Luminaire output 9°x20°: 127lm@ta25°C
- RG: 2<183cm

Rev. 4 - 20/11/19

Details

- Conformity with CEE directives
- Class III
- IK08
- RG1
- RG2
- CRI>80
- IP 67

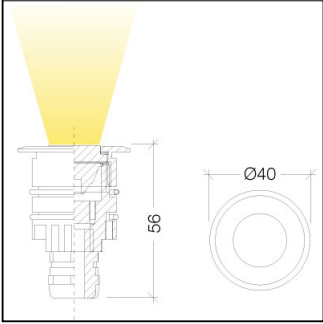

350/500/ 700mA 1/2/3W
CE IK08 RG RG CRI ≥ 80 IP67

