



## Use and maintenance instructions

### Luna

Outdoor luminaire suitable for installation on poles Ø60mm

TECHNICAL DETAILS: please refer to the product label

 The UE declaration of conformity can be downloaded from our website [www.marecoluce.it](http://www.marecoluce.it)

 Insulation Class II

**IP65** Protection degree against dust ingress, solid particles, moisture

 **Led Version**  
Caution, risk of electrical shock.  
The lighting source of this luminaire must be replaced by the Manufacturer only

 **Led Version**  
This luminaire holds a lighting source in "E" energy efficiency class.

 This product must not be disposed as a normal household waste

### WARNINGS:

- THE SAFETY OF THIS PRODUCT IS GUARANTEED ONLY WITH THE RESPECT OF THE EXISTING RULES FOR THE ELECTRICAL SYSTEMS, AND WITH THE APPROPRIATE USE OF THESE INSTALLATION INSTRUCTIONS, THEREFORE IT IS NECESSARY TO KEEP THEM
- THE IMPROPER USE OF THIS PRODUCT IS FORBIDDEN; ANY TAMPERING WITH THE PRODUCT OR MODIFICATION OF THE PRODUCT THAT IS NOT AUTHORIZED BY MARECO LUCE CAN CAUSE DAMAGE TO PEOPLE, ANIMALS OR THINGS, AND WILL VOID ANY WARRANTY OR LIABILITY.
- SWITCH OFF THE ELECTRICITY BEFORE CONDUCTING ANY KIND OF MAINTENANCE.
- THIS PRODUCT IS SUITABLE FOR OUTDOOR INSTALLATION ONLY
- THE PRODUCT MUST BE INSTALLED IN ACCORDANCE WITH BEST PRACTICE
- DAMAGED COMPONENTS MUST BE REPLACED WITH MARECOLUCE ORIGINAL SPARE PARTS
- DO NOT PLACE ANY OBJECT ON THE LUMINAIRE AND DO NOT COVER IT.
- FOR FBT VERSION MAX. LAMP SIZE (IN MM):

10W D60 L110

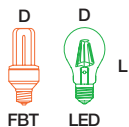

### GENERAL MAINTENANCE RECOMMENDATIONS:

- CLEAN THE LUMINAIRE PERIODICALLY TO REMOVE POSSIBLE DIRT DEPOSITS THAT MAY DAMAGE IT OR ALTER THE PHOTOMETRICS PERFORMANCE.
- DO NOT USE HARSH DETERGENTS, ABRASIVE CLOTHES, HIGH-PRESSURE WASHERS, WATER AT A TEMPERATURE HIGHER THAN 60°C TO CLEAN THE LUMINAIRE.
- CHECK THE INTEGRITY OF THE FITTING COMPONENTS: REPLACE THEM IN CASE OF DAMAGE BY USING ONLY ORIGINAL MARECO LUCE PARTS.
- CHECK THE PLASTIC CASINGS CAREFULLY IN ORDER TO IDENTIFY ANY POSSIBLE INSULATION DAMAGE.

### INSTALLATION INSTRUCTIONS:

1. Connect the cable out of the fitting (1) to the main supply by respecting the polarities.

**CAUTION:** For a correct installation, we recommend to ensure a watertight connection between the supply cables and to use only a flexible double insulation sheath (type HAR) or one suitable for outdoor use.

2. Secure the fitting on the pole, or wall bracket. For the installation of Luna - FBT version, please proceed as follows.

3. Remove the diffuser (2) to access to the lamp holder (3) .

4. Insert the lamp (NOT included with the luminaire).

5. Place the diffuser (2) on the body and fully rotate it clockwise, paying

Luna FBT

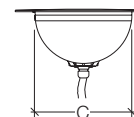
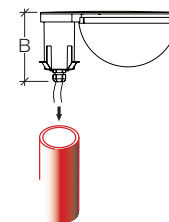
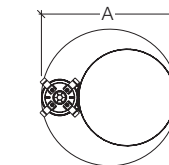
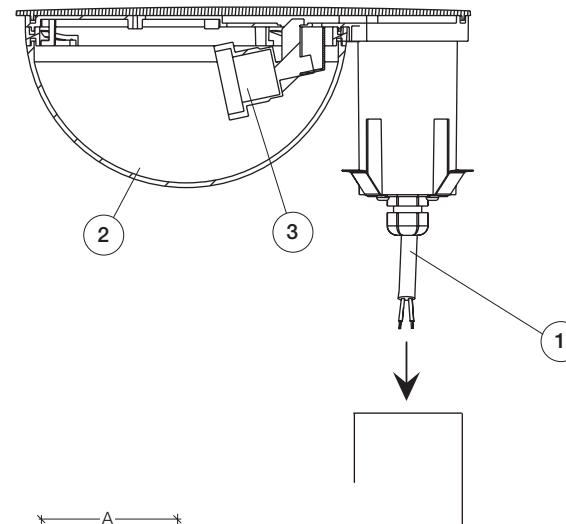
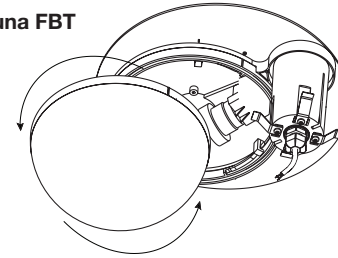

A - Ø240  
B - 121  
C - Ø170  
Adapter Ø60

   
Max thickness pole 3mm

Luna LED

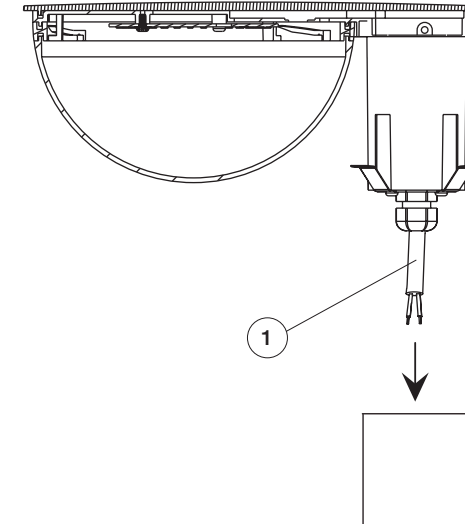
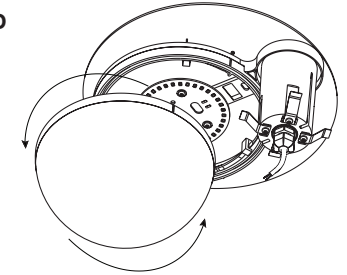

Installation on poles

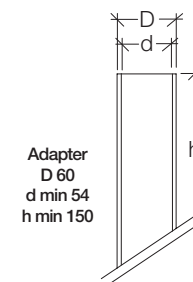

Adapter  
D 60  
d min 54  
h min 150

Size in mm