



Use and maintenance instructions

Delux wall 360°

Fixed bollard for outdoor use, to be installed on concrete plinth

TECHNICAL DETAILS: refer to the product label

 The UE declaration of conformity can be downloaded from our website www.marecoluce.it

 Insulation Class II

IP65 Protection degree against dust ingress, solid particles, moisture

 This luminaire holds a lighting source in “F” energy efficiency class.

SVM>0,9 This product is intended for use in outdoor applications, industrial applications and other applications for which lighting standards allow a CRI <80.

 Caution, risk of electrical shock. The lighting source of this luminaire must be replaced by the Manufacturer only

 This product must not be disposed as a normal household waste

WARNINGS.

- THE SAFETY OF THIS PRODUCT IS GUARANTEED ONLY WITH THE RESPECT OF THE EXISTING RULES FOR THE ELECTRICAL SYSTEMS, AND WITH THE APPROPRIATE USE OF THESE INSTALLATION INSTRUCTIONS, THEREFORE IT IS NECESSARY TO KEEP THEM.
- THE IMPROPER USE OF THIS PRODUCT IS FORBIDDEN; ANY TAMPERING WITH THE PRODUCT OR MODIFICATION OF THE PRODUCT THAT IS NOT AUTHORIZED BY MARECO LUCE CAN CAUSE DAMAGE TO PEOPLE, ANIMALS OR THINGS, AND WILL VOID ANY WARRANTY OR LIABILITY.
- SWITCH OFF THE ELECTRICITY BEFORE CONDUCTING ANY KIND OF MAINTENANCE.
- THE PRODUCT MUST BE INSTALLED IN ACCORDANCE WITH BEST PRACTICE.
- DAMAGED COMPONENTS MUST BE REPLACED BEFORE PUTTING THE PRODUCT BACK INTO SERVICE WITH MARECOLUCE SPARE PARTS.
- DO NOT COVER OR OBSCURE THE DIFFUSER.

GENERAL MAINTENANCE RECOMMENDATIONS:

- CLEAN THE LUMINAIRE PERIODICALLY TO REMOVE POSSIBLE DIRT DEPOSITS THAT MAY DAMAGE IT OR ALTER THE PHOTOMETRICS PERFORMANCE.
- DO NOT USE HARSH DETERGENTS, ABRASIVE CLOTHES, HIGH- PRESSURE WASHERS, WATER AT A TEMPERATURE HIGHER THAN 60°C TO CLEAN THE LUMINAIRE.
- THE BASE AND THE OTHER PARTS OF THE PRODUCT CANNOT BE COVERED BY SOIL OR PUT IN CONTACT WITH AGGRESSIVE CHEMICAL SUBSTANCES.
- CHECK THE TIGHTNESS OF THE SCREW SECURING THE FITTING.
- CHECK THE INTEGRITY OF THE FITTING COMPONENTS: REPLACE THEM IN CASE OF DAMAGE BY USING ONLY ORIGINAL MARECO LUCE PARTS
- CHECK THE PLASTIC CASINGS CAREFULLY IN ORDER TO IDENTIFY ANY POSSIBLE INSULATION DAMAGE
- IT IS RECOMMENDED TO USE SILICONE GREASE ON THE THREADED PARTS OF THE CLOSING SCREWS IN ORDER TO MAKE FUTURE MAINTENANCE

Rev. 3-01/03/2022

INSTALLATION INSTRUCTIONS:

1. Unscrew the screws (1) and remove the bracket (2).
2. Fasten the bracket (2) to the wall by using some screws and expansion plugs (NOT included); apply 2.5 Nm.
3. Connect the luminaire to the mains using a suitable connection for the installation that you are conducting; pay attention to respect the polarities and the insulation class of the luminaire.
4. Insert the luminaire (3) into the bracket (2) and tighten the screws (1).

PLEASE NOTE:
The optional accessories (connectors) **CANNOT** be placed inside the luminaire.

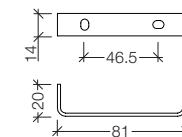
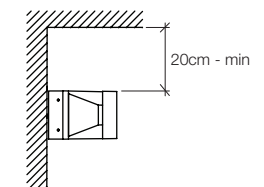
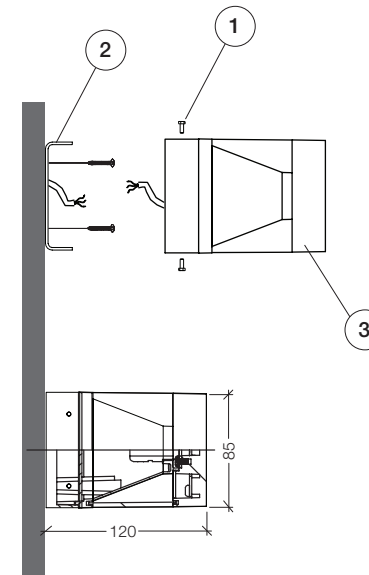
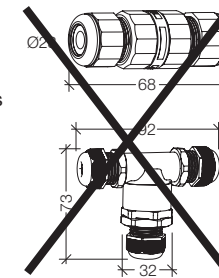

Bracket for wall fixing:
Ø5mm fixing holes