



Use and maintenance instructions

Tao FBT

Outdoor luminaire suitable for installation on Ø60mm poles/brackets

TECHNICAL DETAILS: refer to the product label

 The UE declaration of conformity can be downloaded from our website www.marecoluce.it

 Insulation Class II

IP55 Protection degree against dust ingress, solid particles, moisture

 This product must not be disposed as a normal household waste

WARNINGS:

- THE SAFETY OF THIS PRODUCT IS GUARANTEED ONLY WITH THE RESPECT OF THE EXISTING RULES FOR THE ELECTRICAL SYSTEMS, AND WITH THE APPROPRIATE USE OF THESE INSTALLATION INSTRUCTIONS, THEREFORE IT IS NECESSARY TO KEEP THEM.
- THE IMPROPER USE OF THIS PRODUCT IS FORBIDDEN; ANY TAMPERING WITH THE PRODUCT OR MODIFICATION OF THE PRODUCT THAT IS NOT AUTHORIZED BY MARECO LUCE CAN CAUSE DAMAGE TO PEOPLE, ANIMALS OR THINGS, AND WILL VOID ANY WARRANTY OR LIABILITY.
- SWITCH OFF THE ELECTRICITY BEFORE CONDUCTING ANY KIND OF MAINTENANCE.
- THE PRODUCT MUST BE INSTALLED IN ACCORDANCE WITH BEST PRACTICE.
- DAMAGED COMPONENTS MUST BE REPLACED WITH MARECOLUCE ORIGINAL SPARE PARTS.
- MAX LAMP SIZE (IN MM):

30W D60 L190

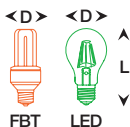

GENERAL MAINTENANCE RECOMMENDATIONS:

- CLEAN THE FITTING PERIODICALLY TO REMOVE POSSIBLE DIRT DEPOSITS ON THE DIFFUSER.
- CHECK THE TIGHTNESS OF THE LUMINAIRE TO THE POLE BY REFERRING TO THE INSTALLATION INSTRUCTIONS.
- CHECK THE INTEGRITY OF THE DIFFUSER: REPLACE IT IN CASE OF DAMAGE, BY USING ONLY AN ORIGINAL MARECO LUCE DIFFUSER.
- DO NOT USE HARSH DETERGENTS TO CLEAN THE DIFFUSER.
- CHECK THE PLASTIC CASINGS CAREFULLY IN ORDER TO IDENTIFY ANY POSSIBLE INSULATION DAMAGE.

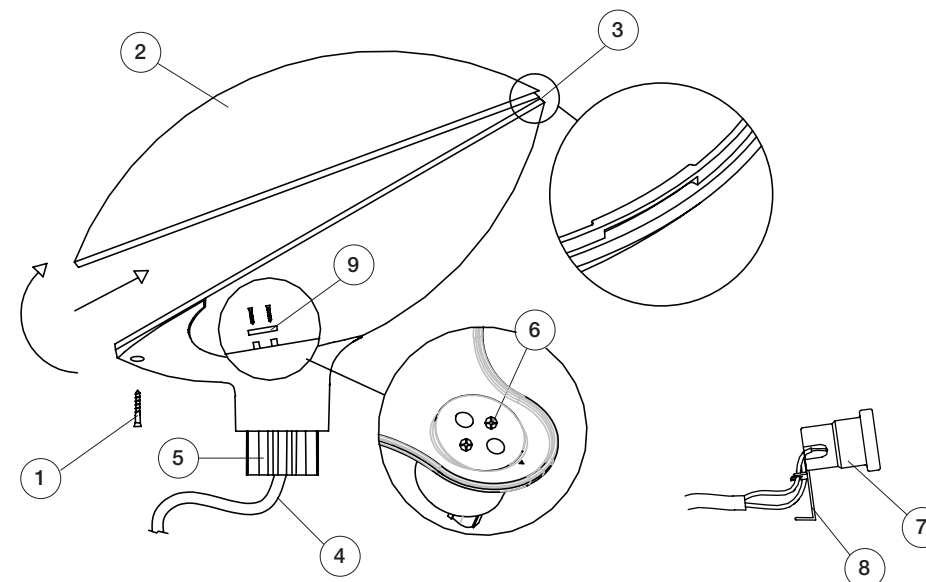

INSTALLATION INSTRUCTIONS:

1. Untighten the screws (1) and remove the top cover (2): slightly lift the cover and slide it ahead by paying attention not to stress the joint between cover and diffuser (3).
2. Insert the supply cable (4) through one of the two holes on the bottom part of the base (5).

CAUTION: use only a flexible double insulation sheath (type HAR). The outer cable diameter must be lower than 11mm and the thickness of the inner electrical wires must range between 0,5 and 2,5 mmq.

3. Insert the bottom end of the base (5) in the pole/bracket and tighten the expander screws uniformly (6).
4. Unsheathe and strip the supply cable (4) as indicated in pict. A. Connect the electrical wires directly to the lamp holder (7) by blocking them in the rings of the lamp holder support (8).
5. Block the supply cable with the cable block (9).
6. Put back the top cover in its original position (2) and be careful to the joint with the diffuser (3) and to keep the gasket in the correct position, then tighten the screws (1).

PIC. A

CABLE STRIPPING

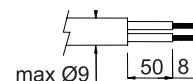

Installation on brackets

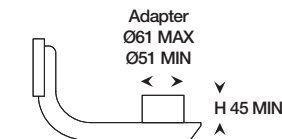

Installation on poles

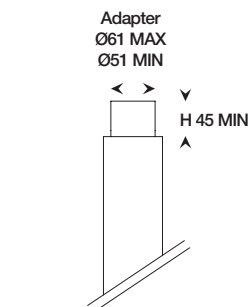

Measures expressed in mm